

BRAUN

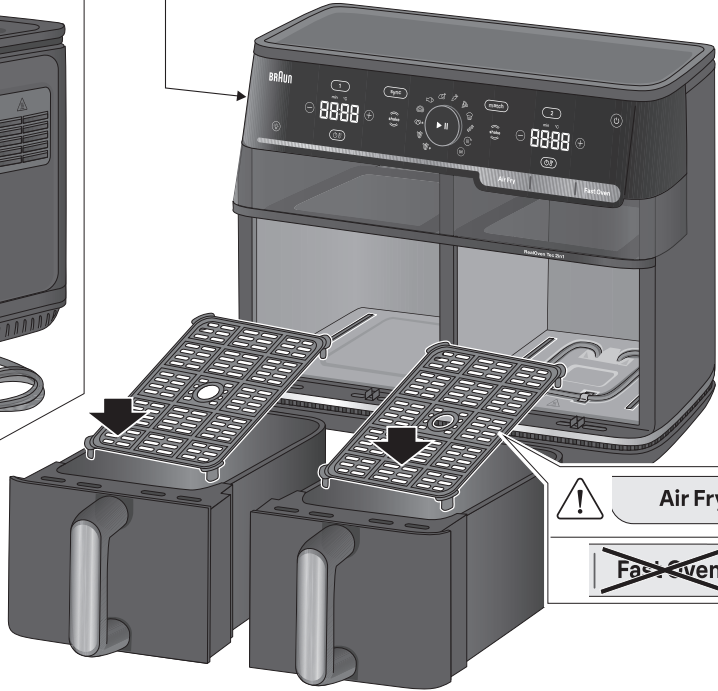

Type TD5053I, TD5073I

Hot Air Fryer

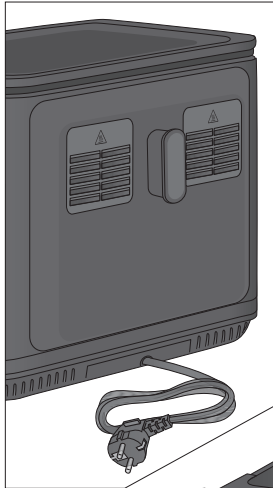

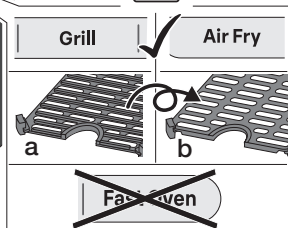
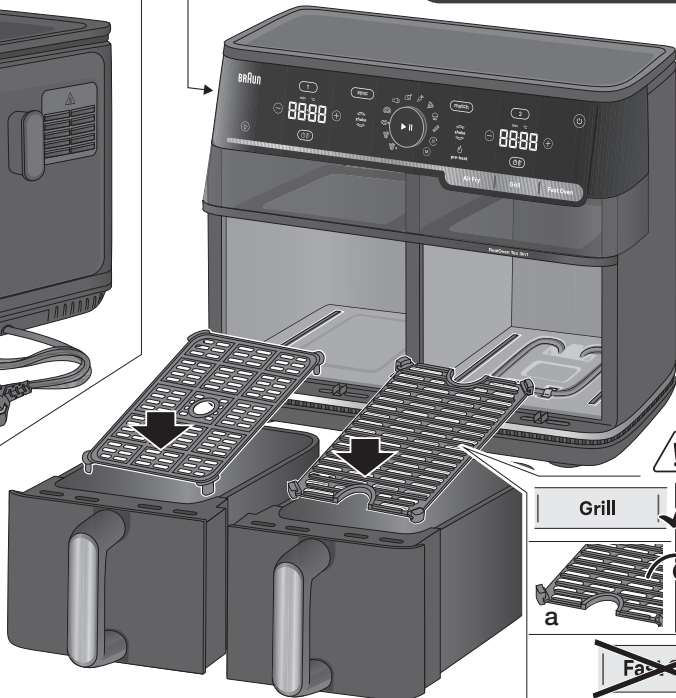
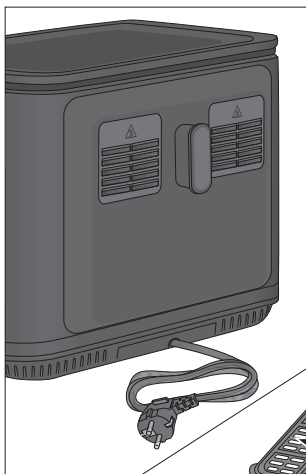

B

1st 

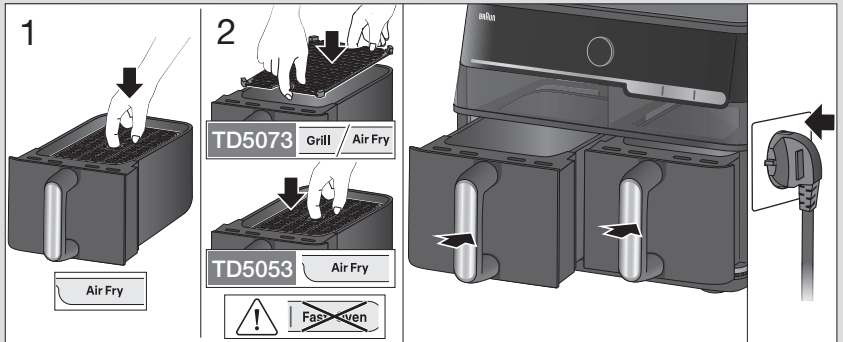
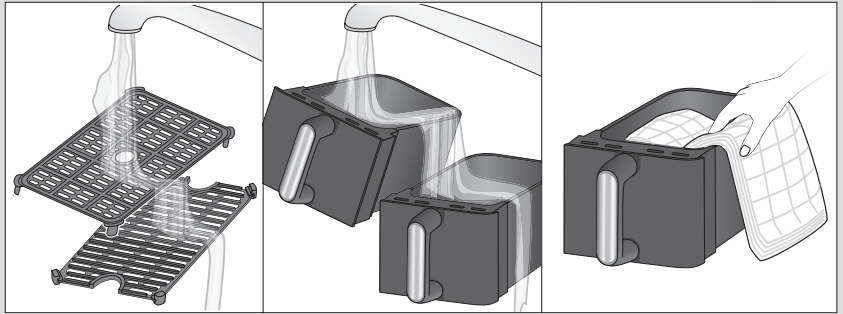
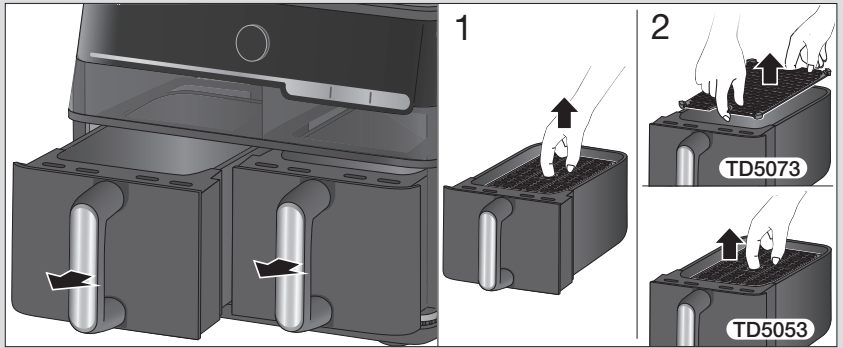

C

TD5053



Air Fry

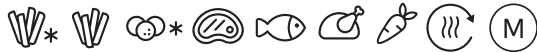
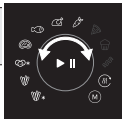

Fast Oven

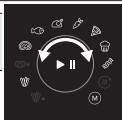

TD5073

Air Fry

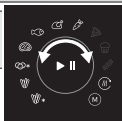

Grill

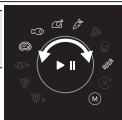

Fast Oven

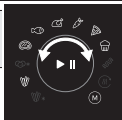

D



1

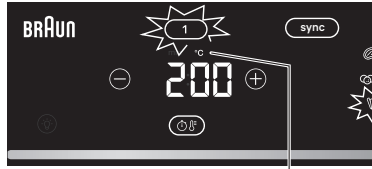

°C

2

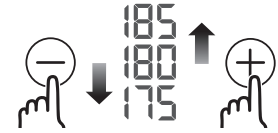
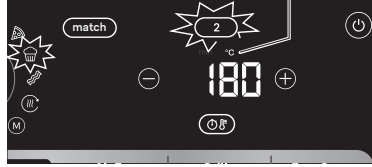

1

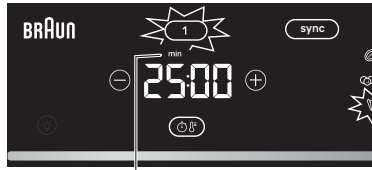

min

2



E TD5073

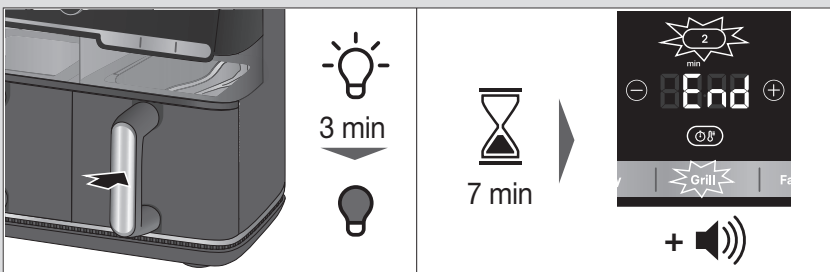
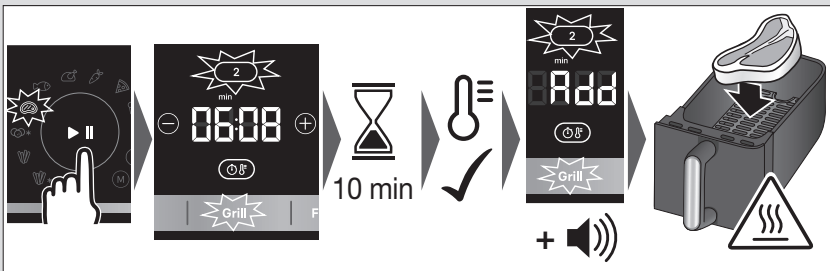
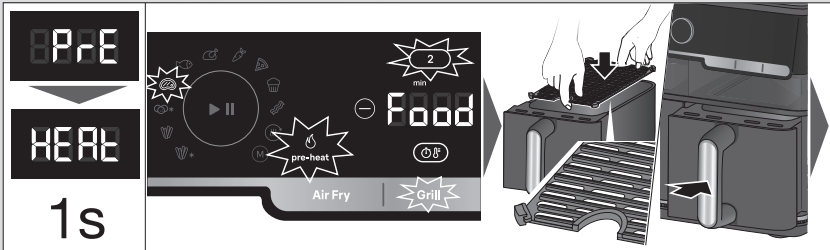
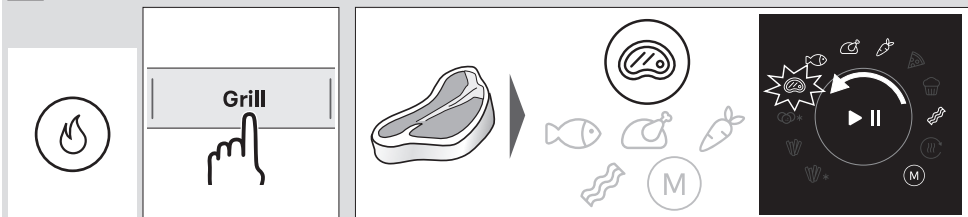

TD5053 + TD5073

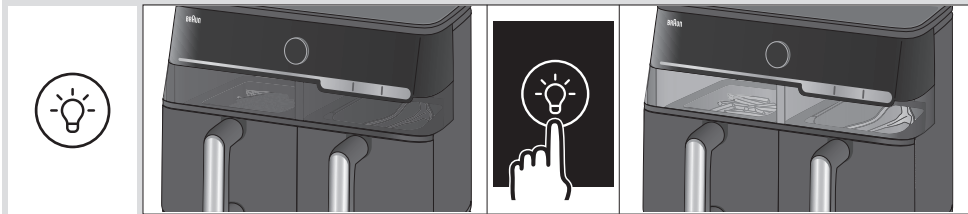

F

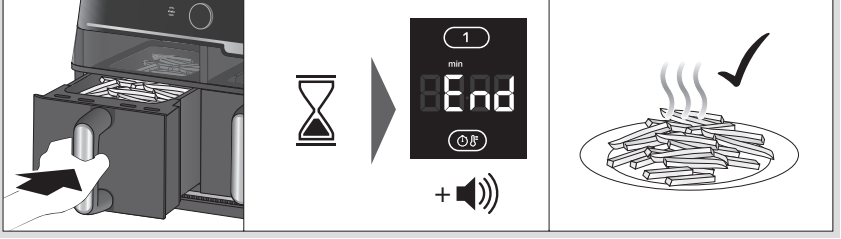
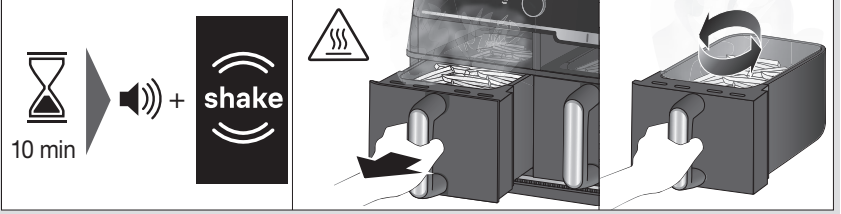
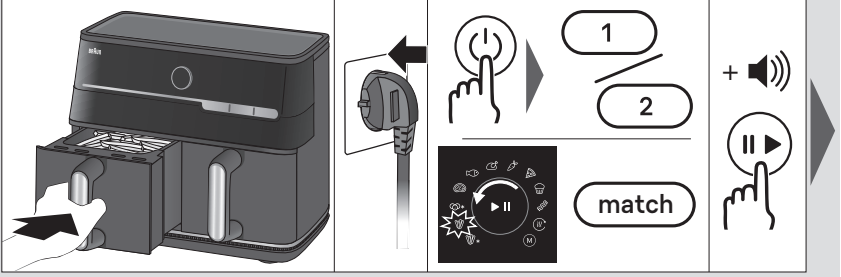
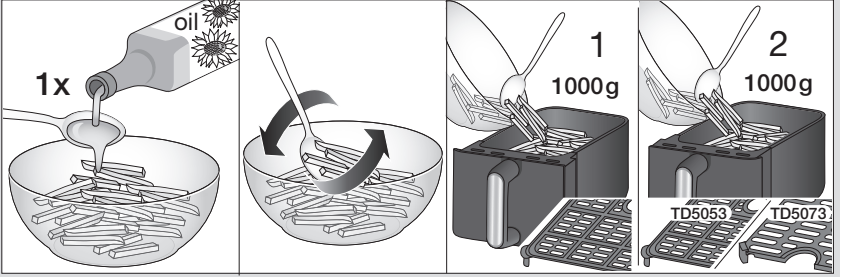
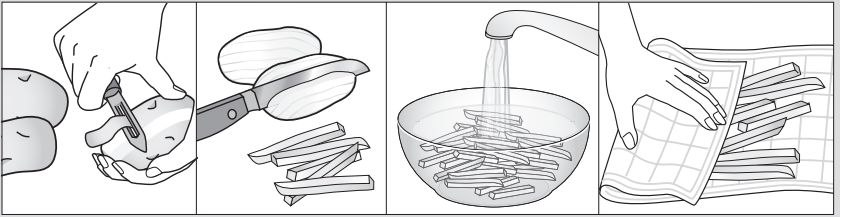





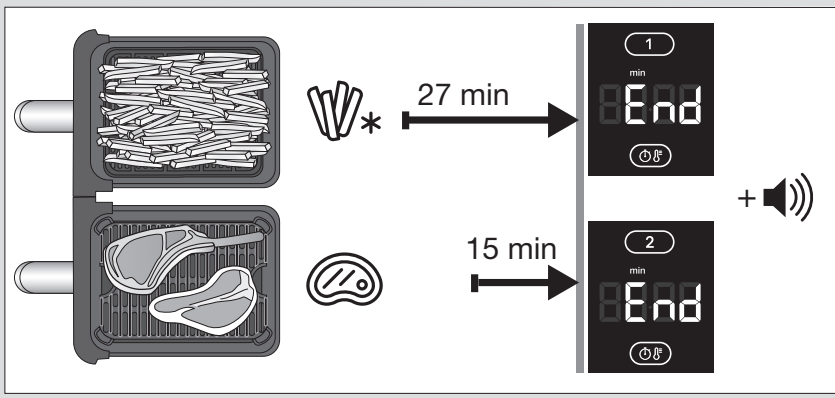
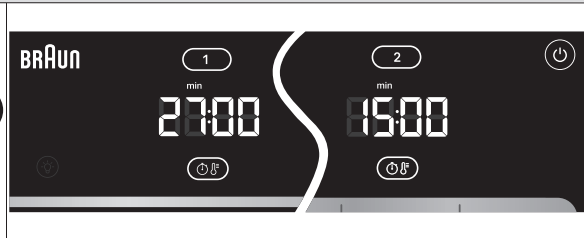
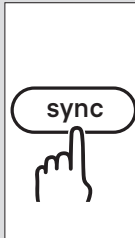
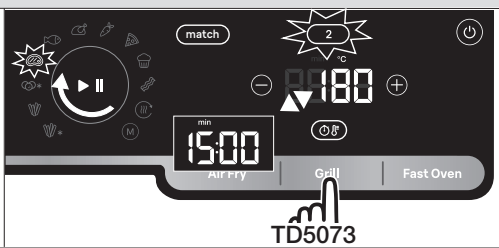
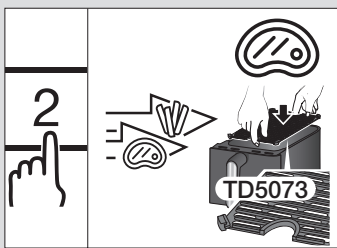
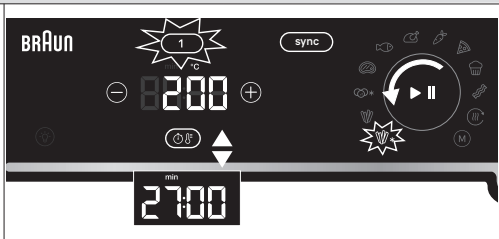
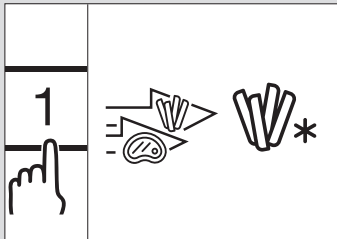

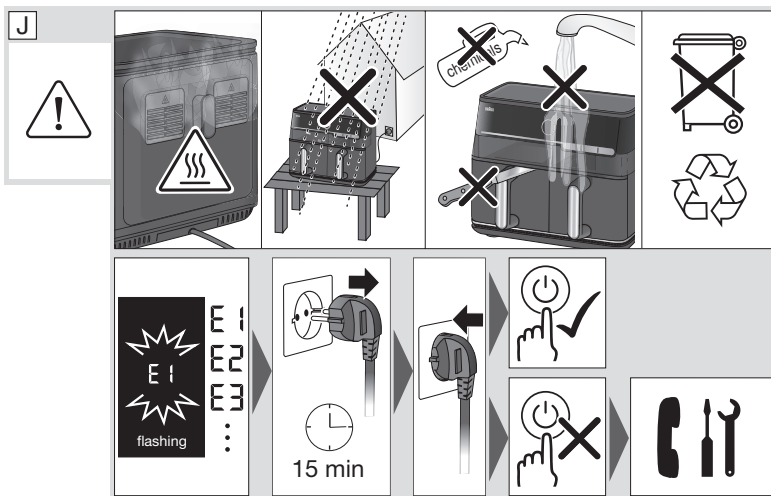
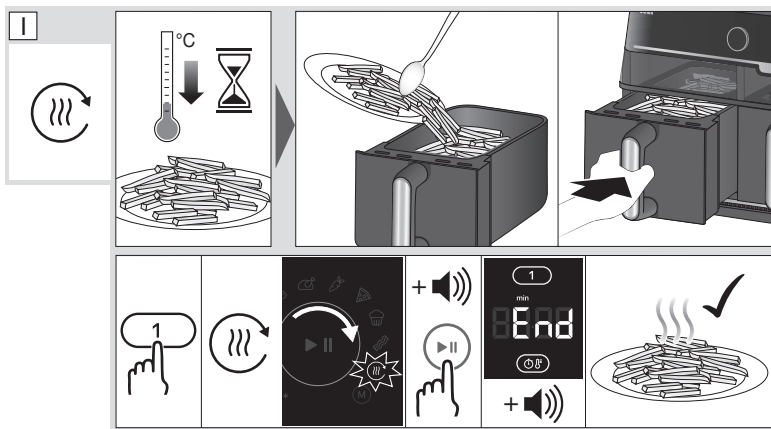
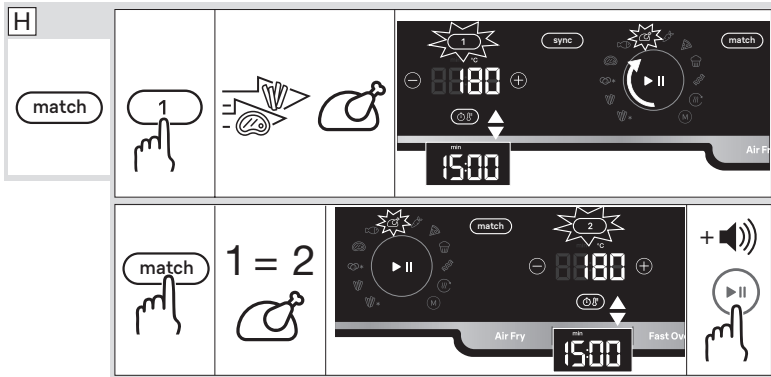







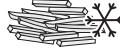



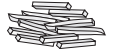



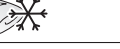













































G

sync





Preset Air Fry			 g	 min.	 °C		
 *		 ❄️	10x10 mm	1000	30	180	 shake
			10x10 mm	1000	30	200	 shake
 *		 ❄️		250	15	200	 50%
				3-5 	20	190	 50%
				400	12	200	 50%
		 ❄️		500	12	200	 50%
		  		250	15	180	 50%
Fast Oven							
			25x25 mm	800	30	200	 shake
				600	25	190	 50%
				300	18	180	
				600	30	200	 50%
				600	25	190	
				600	20	190	
				700	35	160	
				4-6 	12	200	 50%
Grill							
				600	7	220	
				150	8	190	
				300	7	200	
				300	10	200	
				4 	6	200	

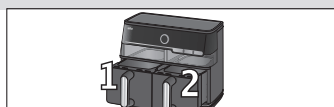

	10x10 mm
	7x7 mm
	10x10 mm
	25x25 mm

1	2 RealOven Tec 2in1 / RealOven Tec 3in1		
	Air Fry	Grill	Fast Oven

g	min.	°C	
500 1200	18 33	180	
500 1200	20 35	180	
500 1200	15 30	180	
500 1200	25 40	200	
500 1200	30 45	200	
500 1200	25 40	200	
500 1200	30 45	200	

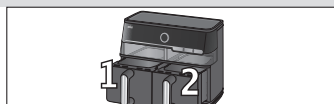

1	2 RealOven Tec 2in1 / RealOven Tec 3in1		
	Air Fry	Grill	Fast Oven

g	min.	°C	
200 250	12 15	200	50%
400 600	8 10	200	50%
350 400	30 35	160	
200 250	12 15	180	50%
300 400	12 15	200	50%
500 900	18 28	180	50%
500 800	25 30	190	
200 300	8 10	200	50%
2-4	18 20	200	

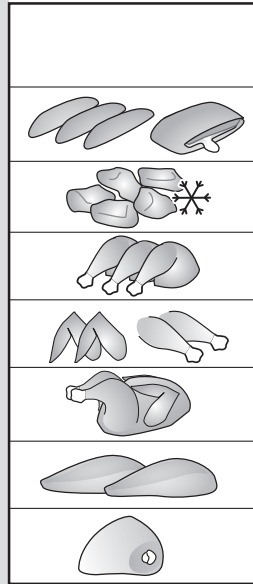
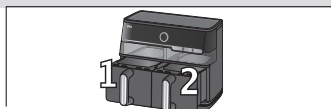

2 RealOven Tec 2in1 / RealOven Tec 3in1		
Air Fry	Grill	Fast Oven

 MIN MAX g	 min.	 °C	
400 500	12 15	200	50%
400 500	10 12	200	50%
400 600	25 30	200	50%
400 600	25 30	200	50%
800 1200	40 50	200	50%
200 300	6 8	200	50%
400 500	25 30	200	50%

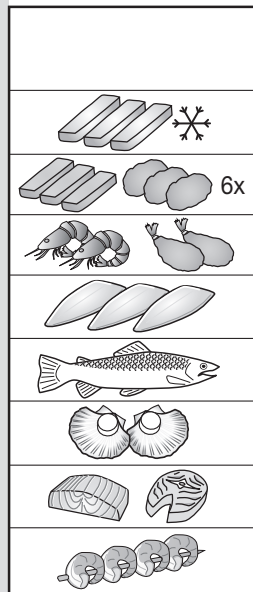

2 RealOven Tec 2in1 / RealOven Tec 3in1		
Air Fry	Grill	Fast Oven

 MIN MAX g	 min.	 °C	
300 400	12 15	200	50%
400 500	12 15	200	50%
200 300	12 15	200	
250 300	15 18	180	
500 600	20 25	180	
3	10 12	180	
500 600	20 25	190	50%
100 150	6 8	190	50%

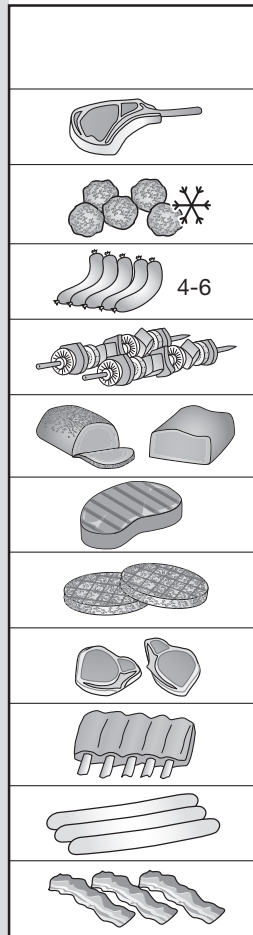

1

2 RealOven Tec 2in1 / RealOven Tec 3in1		
Air Fry	Grill	Fast Oven

 g	 min.	 °C	
3-5	15 20	190	50%
400 500	12 15	190	50%
500 600	12 15	190	50%
400 600	20 25	190	50%
800 1000	50 60	180	50%
500 600	6 8	220	50%
400 500	8 10	210	50%
400 500	12 15	200	50%
500 700	20 25	190	 shake
4-6	12 15	200	50%
4	4 6	200	50%

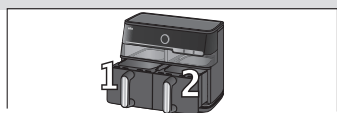

Quiche Lorraine
3

2 RealOven Tec 2in1 / RealOven Tec 3in1		
Air Fry	Grill	Fast Oven

g	min.	°C
500 600	15 20	190
300 400	12 15	190
800 1000	45 50	190
150 200	20 25	190
4 - 6	12 15	160
600 700	30 35	160
250 300	15 20	160
5 - 6	15 20	160
150 200	20 25	160

2 RealOven Tec 2in1 / RealOven Tec 3in1		
Air Fry	Grill	Fast Oven

g	min.	°C
	15	180
	12	200
	25	190

K

